

INSTALLATION / OPERATING INSTRUCTIONS

NOTE: When selecting a shank, select the shortest unit that provides clearance with all the accessories on the tow vehicle and the trailer. This will maximize weight distributing and handling characteristics.

DO NOT EXCEED TOWING VEHICLE MANUFACTURER'S LOAD RATINGS**INTRODUCTION**

When a trailer is hitched to a tow vehicle, the tongue weight typically causes the rear of the tow vehicle to lower and the front to raise. See Figure 1.

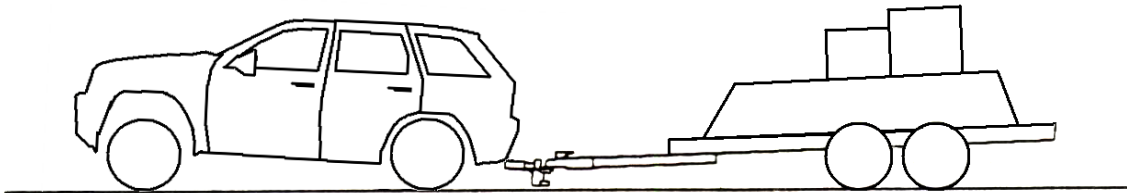

Figure 1

The purpose of a weight distributing hitch is to remove excessive weight from the tow vehicle's rear axle and distribute it to the front wheels and the trailer wheels. See Figure 2.

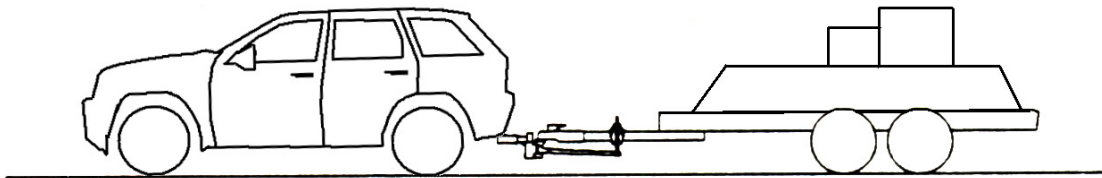

Figure 2

SETUP DIMENSIONS

1. Line up tow vehicle and trailer on level pavement, in a straight-ahead position, uncoupled.
2. For vehicles with air springs, air shocks or automatic leveling systems, check vehicle owner's manual.

Unless otherwise specified, level the vehicle with the vehicle loaded as it **will be** when towing. Deactivate load leveling system before coupling trailer and adjusting spring bars.

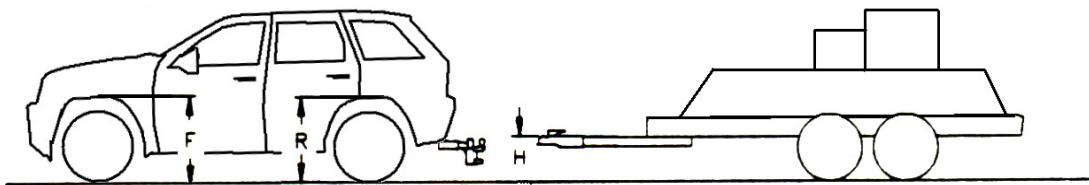

Figure 3

3. Measure and record uncoupled height on front and rear wheel openings to pavement and level trailer coupler height. See figure 3.

F = _____ R = _____ H = _____

Parts List		
ITEM	QTY	DESCRIPTION
1	1	17300's HITCH HEAD WELDMENT
2	1	SHANK BAR WELDMENT
3	2	SPRING BAR ASSEMBLY (DS & PS)
4	2	SNAP-UP BRACKET ASSEMBLY
5	1	PIPE HANDLE ASSEMBLY
6	2	LIFT CHAIN / ZINC GB / T5802-1986 8.00 mm x 400 mm
7	1	5/8-11 UNC x 1-3/4" LG HEX BOLT / GR 5 / ZINC
8	2	3/4-10 UNC x 5" LG / GR 5 / ZINC BOLT
9	4	3/4" SERRATED CONICAL WASHER / ZINC
10	2	3/4-10 UNC NYLOCK NUT / ZINC
11	1	5/8" DIAMETER x 3" CLEVIS PIN
12	1	F-5 CLIP / CURRENTLY SOLD AND LISTED AS THE F-6
13	1	1-1/4" TO 1" BUSHING
14	2	3/8-16 UNC U-BOLT / THREAD LENGTH 3/4" / ZINC
15	4	3/8" SPLIT LOCK WASHER / ZINC
16	4	3/8-16 UNC NYLOCK NUT / ZINC
17	2	1/2-13 UNC x 2" LG / FULL THREAD / GR 5 / ZINC
18	2	1/2-13 UNC x 4" LG / FULL THREAD / GR 5 / ZINC
19	2	SNAP-UP BRACKET HAIR PIN CLIP
20	1	TILT ADJUSTMENT ROD 1
21	1	TILT ADJUSTMENT ROD 2
22	2	1/2" USS FLAT WASHER / ZINC
23	3	DATE CODE LABEL

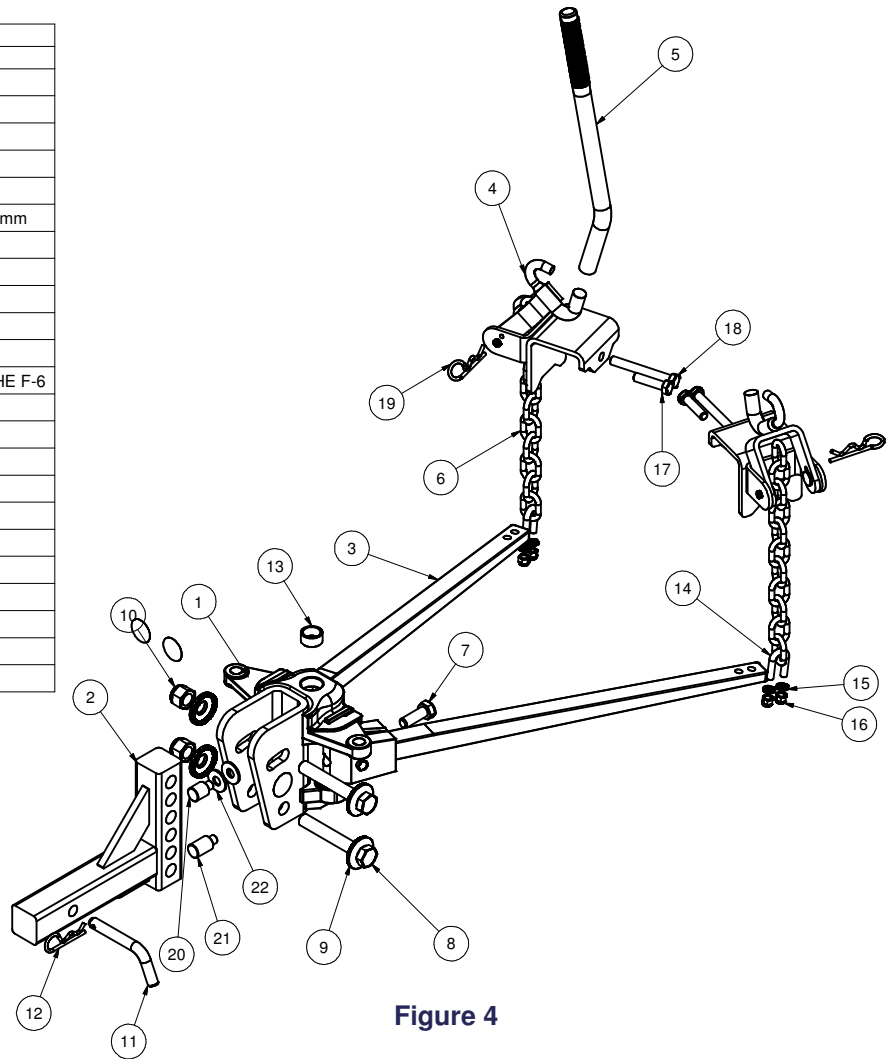

Figure 4

READ ALL INSTRUCTIONS AND CHECK PACKAGE CONTENTS

ASSEMBLE SYSTEM

1. Insert shank into receiver and install pin and clip. See Figure 4.
2. Select hitch ball to match trailer coupler socket, having 1" or 1 1/4" threaded shank and capacity equal to or exceeding the gross trailer weight. When using a ball with a 1" shank, bushing (13) must be used. Attach the ball to the head assembly (1) using a **lockwasher** and nut.
3. Assemble head to shank as shown in Figure 4. Use washers (22) over pin (20 or 21) initially.
4. Align head assembly bolt holes to the nearest holes on shank that corresponds to a ball height **approximately 1.5 - 2" higher** than trailer coupler height "H" when trailer is level. Leave fasteners loose until hookup has been adjusted.
5. Tighten ball nut according to manufacturer's specs. **Always use a lockwasher.**
6. Assemble chains to spring bars as shown in Figure 4. Allow 2 - 3 threads to protrude below locknut **Chain must not bind.**
7. Lower trailer coupler onto hitch ball and close coupler latch.
8. Apply a heavy oil or wheel bearing type grease to the upper and lower trunnion pin of each spring bar assembly.

9. Hold the spring bar (3) perpendicular to the shank (2). Insert the lower trunnion pin into the lower pocket of the head assembly (See figure 6). Rotate the spring bar so the upper trunnion pin passes through the entrance slot in the upper pocket of the head assembly.

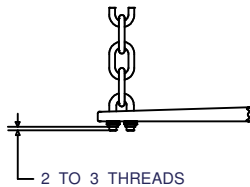

Figure 5

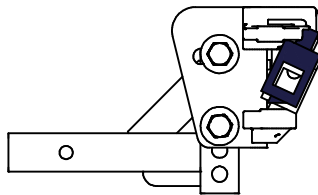

Figure 6

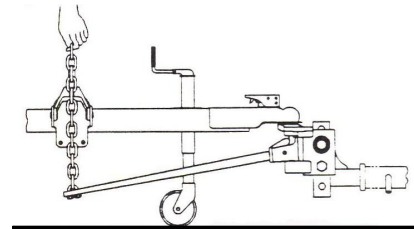

Figure 7

10. Position snap-up brackets on trailer "A" frame. Hold spring bar chain vertical. Center snap-up brackets with chain. (See figure 7)
11. Turn 1/2-13 x 4" bolt until it contacts the frame. Then tighten 1/2 - 3/4 turn with wrench. **DO NOT OVER TIGHTEN. NOTE:** If "A" frame is quite large, a 1/2-13 x 2" bolt is supplied to replace the 4" bolt. If a trailer doesn't permit the use of 1/2-13 bolt, drill optional holes large enough for the recommended 3/8" hardware whether it is self-tapping or nut and bolt. **CONSULT TRAILER FRAME MANUFACTURER FOR APPROVAL PRIOR TO DRILLING HOLES.**

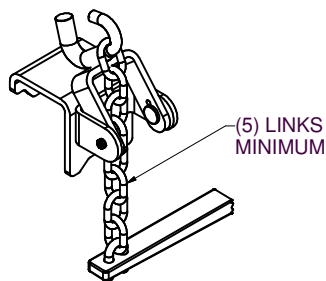

Figure 8

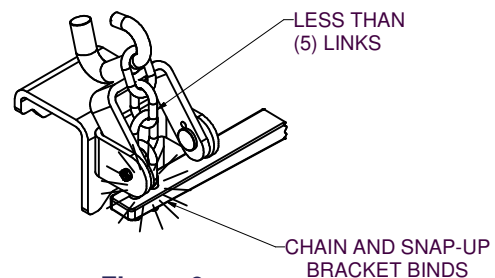

Figure 9

SPRING BAR CHAIN CONNECTION

1. With snap-up bracket in raised position, pull straight up firmly on spring bar chain. Note which link is closest to chain hook (See figure 7). Countdown (2) links and that link will be used for hook up.
NOTE:
BEFORE OPERATING SNAP-UP BRACKET, RAISE BUMPER OF TOW VEHICLE WITH THE TRAILER TONGUE JACK APPROXIMATELY ONE INCH. THIS WILL REDUCE SPRING BAR TENSION AND MAKE SNAP-UP BRACKET OPERATION EASIER.
2. Lower snap-up bracket. Attach upper end of chosen chain link to snap-up bracket hook, while allowing remaining free links to fall down to the outside of the trailer frame.
3. **THERE MUST BE AT LEAST 5 LINKS BETWEEN THE SNAP-UP BRACKET AND THE SPRING BAR.** This is necessary for proper operation of the spring bars during turns (See figure 8). **IF THERE WILL BE LESS THAN 5 LINKS** between the snap-up bracket and spring bar, the angle of the head assembly (1) must be increased. The trailer must be uncoupled and the upper bolt removed from the head assembly. The head assembly is then pivoted down and an additional washer is added underneath the pin (See figure 4). Reassemble.

CAUTION: FAILURE TO CONNECT THE SPRING BAR CHAIN CORRECTLY AND PROVIDE AT LEAST 5 LINKS BETWEEN SNAP-UP BRACKET AND SPRING BAR CAN RESULT IN DAMAGE TO THE SNAP-UP BRACKET. FIGURE 9 SHOWS INCORRECT SPRING BAR CHAIN HOOK UP.

4. Use handle to raise snap-up bracket. **WARNING:** Keep clear of all moving parts.
5. Insert spring clip on snap-up bracket.
6. Repeat for opposite spring bar, using same number of links between hook and spring bar.
7. Retract trailer tongue jack so hitch is now carrying the full trailer weight.

ADJUST HOOKUP (IF NECESSARY)

A weight distributing system is properly set up and coupled when the tow vehicle has settled with the front wheel opening "F" at the original uncoupled dimension measured and slightly lower in the rear "R". See **Figure 11**.

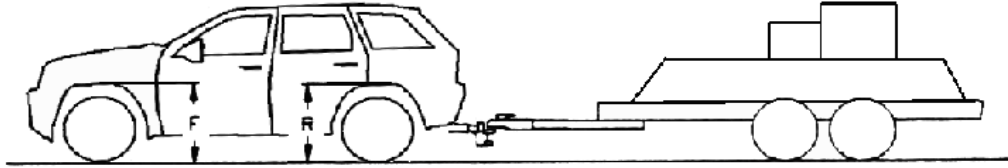
**Figure 10**

- This will assure the front wheel load remains unchanged. This results in good handling and the desired load on the rear axle.
- The front of the vehicle should never settle more than the rear. See **Figure 12**. If necessary increase the number of chain links between lift unit and spring bar.
- 3/4 - 1 ton and/or long wheelbase vehicles will typically settle with the front wheel opening "F" at the original dimension to 1/2" higher than original. This will still allow acceptable front wheel loads, good handling and the desired load on the rear axle and trailer axle.
- If the rear suspension sags too much, additional leveling is required. The front wheel opening "F" may **ONLY** be settled lower than the original dimension **IF** the rear wheel opening "R" has settled by a greater amount (At least 1").

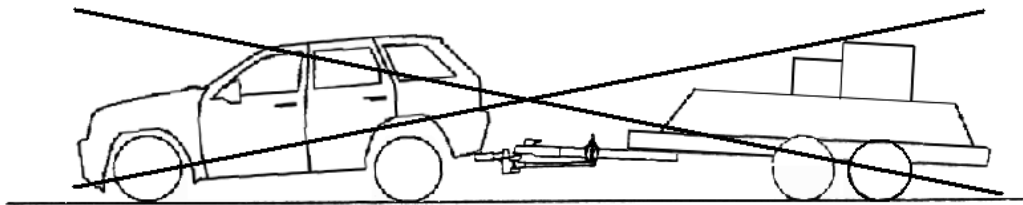
**Figure 11**

1. If additional leveling is required, decrease the number of chain links between snap-up bracket and spring bar.
2. **There must be at least 5 links between the snap-up bracket and the spring bar.** This is necessary for proper operation of the spring bars during turns. If there are less than 5 links, the angle of the head assembly must be increased.
3. When the desired settling is achieved, mark the hooked chain link with paint for future reference.

NOTE:

SURGE BRAKES usually require a small amount of fore-aft movement for their actuating mechanisms to function. To avoid restricting movement, it may be necessary to increase the number of chain links between the snap-up brackets and the spring bars. **CHECK TRAILER AND/OR SURGE BRAKES OPERATING INSTRUCTIONS FOR SPECIAL REQUIREMENTS REGARDING WEIGHT DISTRIBUTING HITCHES.**

TIGHTEN HEAD FASTENERS

1. Tighten 3/4 bolts and locknuts to 200 lb-ft. Tighten setscrew to 50 lb-ft.

CHECK ALL CONNECTIONS BEFORE TOWING

1. Check the following: pin and clip securing shank to receiver, head to shank fasteners, ball nut, coupler latch, snap-up bracket bolt, safety chains, lights and turn signals, and braking system, including breakaway switch.

LUBRICATION

1. **TRUNNIONS SHOULD BE LUBRICATED EACH TOWING DAY. FAILURE TO DO SO WILL RESULT IN EXCESSIVE POCKET AND TRUNNION WEAR.** Use a heavy oil or grease.
2. Excessive oil, dirt, and grit should be wiped out of pockets whenever trailer is uncoupled.
3. Clean hitch ball and coupler socket. Coat ball lightly with grease.

WARNINGS**FAILURE TO HEED MAY RESULT IN SERIOUS PERSONAL INJURY OR DEATH, VEHICLE CRASH, AND/OR PROPERTY DAMAGE**

COUPLED BALL HEIGHT SHOULD NEVER BE GREATER THAN UNCOUPLED BALL HEIGHT. Front wheel overload and loss of rear wheel traction can result. This can lead to unstable handling, reduced braking ability, and a tendency to "jackknife" when turning.

USE EXTREME CAUTION WHEN BACKING UP AND TURNING. DO NOT ALLOW TOW VEHICLE AND TRAILER TO MANEUVER INTO A "JACKKNIFE" POSITION. Components of the hitch and sway control, if applicable, may be forced into damaging contact. If a "jackknife" maneuver has occurred, examine all towing system components for damage or loosening immediately. Repair or replace any damaged components before resuming towing.

DO NOT TOW MULTIPLE TRAILERS. Towing multiple trailers may cause severe instability, loss of control and structural failure.

DO NOT ATTEMPT TO HOOK-UP OR TOW WITH A FRONT WHEEL DRIVE VEHICLE WITH THE REAR WHEELS REMOVED. This will cause severe instability, loss of control and structural failure.

TOWING TIPS

DRIVING - Good habits for normal driving need extra emphasis when towing. The additional weight affects acceleration and braking, and extra time should be allowed for passing, stopping and changing lanes. Signal well before a maneuver to let other drivers know your intentions. Severe bumps and badly undulating road can damage your towing vehicle, hitch, and trailer, and should be negotiated at a slow, steady speed. **IF ANY PART OF YOUR TOWING SYSTEM "BOTTOMS OUT", OR IF YOU SUSPECT DAMAGE MAY HAVE OCCURRED IN ANY OTHER WAY, PULL OVER AND MAKE A THOROUGH INSPECTION. CORRECT ANY PROBLEMS BEFORE RESUMING TRAVEL.**

CHECK YOUR EQUIPMENT

Periodically check the condition of all your towing equipment and keep it in top condition.

TRAILER LOADING

Proper trailer loading is important. Heavy items should be placed close to the floor near the trailer axle. The load should be balanced side-to-side and firmly secured to prevent shifting. Tongue weight should be about 10 - 15 percent of the gross trailer weight for most trailers. Too low a percentage of tongue weight often produces a tendency to sway.

SWAY CONTROLS

A sway control can help minimize the effects of sudden maneuvers, wind gusts and buffeting caused by other vehicles. Use of a sway control is recommended for trailers with large surface areas, such as travel trailers, and for trailers with low tongue weight percentage.

TIRE INFLATION

Unless specified otherwise by the towing vehicle or trailer manufacturer, tires should be inflated to their maximum recommended pressure.

TOWING VEHICLE AND TRAILER MANUFACTURERS' RECOMMENDATIONS

Review the owner's manual for your towing vehicle and trailer for specific recommendations, capacities, and requirements.

PASSENGERS IN TRAILERS

Trailers should **NOT** be occupied while being towed, under any circumstances.

TRAILER LIGHT, TURN SIGNALS AND ELECTRIC BRAKES

Always hook up trailer lights, turn signals, electric brakes and break-away switch connection(if equipped). Even for short trips.

REMOVE HITCH HEAD WHEN NOT TOWING - Remove hitch head from towing vehicle receiver when not towing. This will prevent contamination of head pockets, reduce chance of striking hitch head on driveway ramps or other objects, and minimize damage in event of a rear-end collision.

Curt Manufacturing Inc., warrants this product to be free of defects in material and/or workmanship at the time of retail purchase by the original purchaser. If the product is found to be defective, Curt Manufacturing Inc., may repair or replace the product, at their option, when the product is returned, prepaid, with proof of purchase. Alteration to, misuse of, or improper installation of this product voids the warranty. Curt Manufacturing Inc.'s liability is limited to repair or replacement of products found to be defective, and specifically excludes liability for incidental or consequential loss or damage.